

VuFone[®] for the Security Pro 4000

INSTALLATION INSTRUCTIONS

About This Document

This document describes the procedures necessary for installing a VuFone in an existing Security Pro 4000 Security System.

For information specific to the Security Pro 4000 Security System, refer to the *CareTaker[®] Plus and Custom Versions Installation Manual* (46-504) and the *Security Pro 4000 Owner's Manual* (46-801).

The following information is included:

| | | | |
|---|---|--|----|
| Overview | 1 | Programming Sequences..... | 6 |
| Tools Needed..... | 1 | Flowchart 1.0 Main Menu Screens | 6 |
| Installation Guidelines..... | 1 | Flowchart 2.0 CONFIGURE PANEL Options | 7 |
| Installation | 1 | Flowchart 2.1 CONFIGURE PHONE Options | 7 |
| Installing the Bus Interpreter Module | 2 | Flowchart 2.2 SET PANEL DELAYS Options | 8 |
| Mounting..... | 2 | Flowchart 3.0 MISC. (MISCELLANEOUS)..... | 8 |
| Wiring the Bus Interpreter Module to the Panel..... | 3 | Flowchart 3.1 DELETE SENSOR TEXT Options..... | 9 |
| Wiring the DIN 8-pin Cable to the Bus Interpreter Module..... | 3 | Flowchart 4.0 CONFIGURE SENSORS..... | 9 |
| Installing the VuFone | 3 | Flowchart 4.1 UPPER SENSORS Options..... | 10 |
| Power Up | 4 | Flowchart 4.2 DELETE SENSORS Options..... | 10 |
| Programming | 4 | Flowchart 4.3 SENSOR TEXT Options | 10 |
| Checking and Changing the Unit ID Number | 4 | Flowchart 4.4 SENSOR TEXT Options (cont.)..... | 10 |
| Programming a Latchkey Sensor Number | 5 | | |
| What to Do Next | 5 | | |

NOTE

This document assumes that the Security Pro 4000 Control Panel (panel) is already installed at the site. If installed, then proceed with reading these instructions to install the VuFone hardware.

If the panel is *not* installed, stop here and refer to the *CareTaker Plus and Custom Versions Installation Manual* (46-504) for panel installation procedures.



Interactive Technologies, Inc.
2266 North Second Street
North Saint Paul, MN 55109
1-800-648-ALARM
Document Number: 46-983 Rev. A

Notices:

FCC Notice: This equipment has been tested and found to comply with the limits for a Class B digital device, pursuant to Part 15 of the FCC Rules. These limits are designed to provide reasonable protection against harmful interference in a residential installation. This equipment generates, uses and can radiate radio frequency energy and, if not installed and used in accordance with the instructions, may cause harmful interference to radio communications. However, there is no guarantee that interference will not occur in a particular installation. If this equipment does cause harmful interference to radio or television reception, which can be determined by turning the equipment off and on, the user is encouraged to try to correct the interference by one or more of the following measures:

- Reorient or relocate the receiving antenna.
- Increase the separation between the equipment and the receiver.
- Connect the equipment into an outlet on a circuit different from that to which the receiver is connected.
- Consult the dealer or an experienced radio/TV technician for help.
- Send for the FCC booklet *How to Identify and Resolve Radio-TV Interference Problems*, available from the U.S. Government Printing Office, Washington, D.C. 20402. Stock Number. 004-000-00345-4.

This device complies with Part 15 of the FCC Rules. Operation is subject to the following two conditions: (1) This device may not cause harmful interference, and (2) this device must accept any interference received, including interference that may cause undesired operation.

This equipment complies with Part 68 of the FCC Rules. On the FCC label affixed to this equipment is the FCC Registration Number and Ringer Equivalence Number (REN) for this equipment. If requested, provide this information to your telephone company.

The REN is used to calculate the maximum number of devices your telephone line will support with ringing service. In most areas, the sum of all device RENs should not exceed 5.0. Contact your local telephone company to determine the maximum REN for your calling area.

If your telephone equipment causes harm to the telephone network, your telephone company may temporarily disconnect your service. If possible, you will be notified in advance. When advance notice is not practical, you will be notified as soon as possible. You will also be advised of your right to file a complaint with the FCC.

Your telephone company may make changes in its facilities, equipment, operations, or procedures that could affect the proper operation of your equipment. You will be given advance notice in order to maintain uninterrupted service.

If you experience trouble with this equipment, please contact:

Interactive Technologies, Inc.
2266 North 2nd Street
North St. Paul, MN 55109
1-800-777-1415

for service and repair information. The telephone company may ask you to disconnect this equipment from the network until the problem has been corrected or until you are sure the equipment is not malfunctioning.

This equipment may not be used on coin service provided by the telephone company. Connection to party lines is subject to state tariffs.

Trademarks:

ITI and CareTaker are registered trademarks of Interactive Technologies, Inc. VuFone and VeriFone are registered trademarks of VeriFone, Inc.

Overview

The VuFone provides a Security Pro 4000 security system user the added advantage of having a telephone and touchpad in a single unit. With the VuFone, the installer can program the control panel (panel) and related devices instead of using the Alphanumeric Touchpad.

The VuFone includes a bus interpreter module that allows the VuFone to communicate with the panel.

The VuFone is designed to be placed on a desktop or table. It consists of a built-in handset, 4 x 20 liquid crystal display (LCD), alphanumeric keypad, and a screen-addressable keypad that gives you complete access to system programming and operation.

Note: Refer to the *operator's manual* that accompanied the VuFone for a full description of the keypad, display, and related indicators.

The basic system configuration consists of three major components: VuFone, bus interpreter module, and Security Pro 4000 panel (see Figure 1).

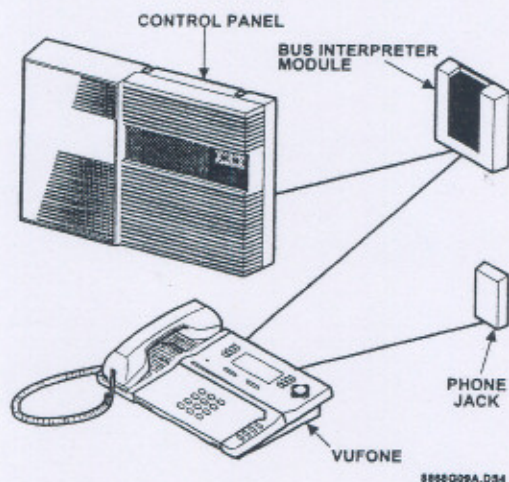

Figure 1. Security Pro 4000/VuFone Configuration

Tools Needed

- Phillips screwdriver
- Flathead screwdriver
- 4-conductor, 22-gauge or greater stranded wire
- Insulated crimp connectors for splicing

The following parts are included with the VuFone:

- Handset/coiled cord
- AC adapter/power cord
- Telephone line cord
- Bus interpreter module (60-623)
- DIN 8-pin cable
- Screws and anchors

Installation Guidelines

Use the following guidelines when adding the VuFone and bus interpreter module to a Security Pro 4000 security system:

- Place the VuFone unit on a smooth, sturdy, level surface.
- Locate the unit near a phone jack and an AC outlet supplying 120 VAC power.
- Avoid locating the VuFone outdoors and in other areas where the following conditions exist: areas of temperature extremes (recommended range is 32–104°F, 0–40°C), damp or dusty areas, electrical noise (such as, appliances, power tools).
- If installing the bus interpreter module using the housing included, locate the bus interpreter module so that the length of the wire run is less than 100 feet from the panel.
- Use 4-conductor, 22-gauge or larger, stranded wire between the bus interpreter module and the VuFone, and between the bus interpreter module and the panel.
- The maximum current draw for VuFone is 30 mA.

Installation

This section describes how to install the VuFone using the following procedures:

- Installing the Bus Interpreter Module
- Installing the VuFone

Installing the Bus Interpreter Module

The bus interpreter module can be installed using the enclosure (included) or the circuit board can be mounted on the panel.

Installing the bus interpreter module involves the following procedures:

- Mounting
- Connecting the panel to the bus interpreter module
- Wiring the DIN 8-pin cable to the bus interpreter module

Mounting

- 1) Remove the enclosure cover by pressing down on the top center of the cover, and pull the cover away from the base (see Figure 2). Set the cover aside.

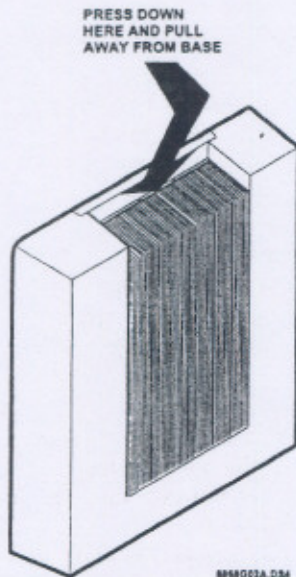

Figure 2. Removing the Enclosure Cover

CAUTION: You must be free of static electricity before handling circuit boards. Discharge yourself by touching a bare metal surface, or wear a grounding strap.

- 2) Press down on the lower-right corner of the base until the latch releases the circuit board (see Figure 3).

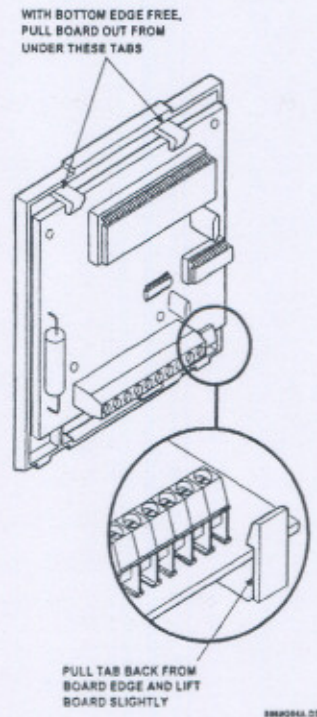

Figure 3. Removing the Circuit Board

- 3) Remove the circuit board from the base by gently lifting the board by the terminal strip until the top two latches release the board (see Figure 3).
- 4) Use step a if mounting the circuit board on the panel. Use steps b and c if mounting the circuit board with the enclosure (included).
 - a. If installing the circuit board on the panel, turn off the panel power switch and mount the bus interpreter module circuit board with the screws included (see Figure 4).

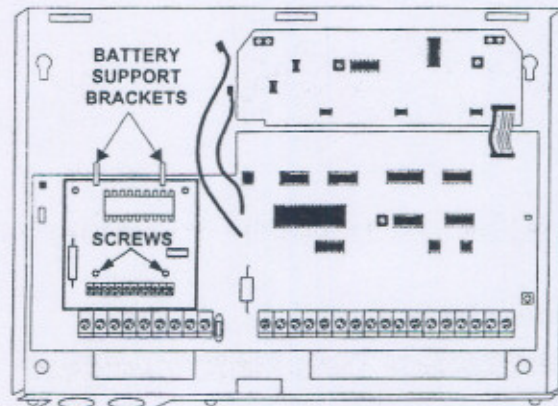

Figure 4. Installing the Circuit Board on the Panel

- b. If installing the bus interpreter module using the enclosure, place the circuit board in the cover and mount the base anchors and screws (included) at the three mounting hole locations (see Figure 5).

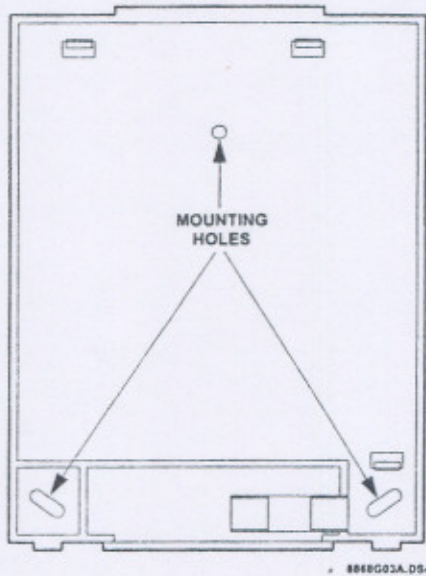

Figure 5. Mounting Hole Locations

Note: Remember to leave several inches below the base bottom to allow room for the wiring.

- c. After the base is mounted, replace the circuit board on the base by first securing the top of the circuit board, then gently press on the bottom until the circuit board snaps under the lower latch.

Wiring the Bus Interpreter Module to the Panel

- 1) Turn off the panel power switch.
- 2) Make wiring connections between the bus interpreter module and the panel as shown in Figure 6.

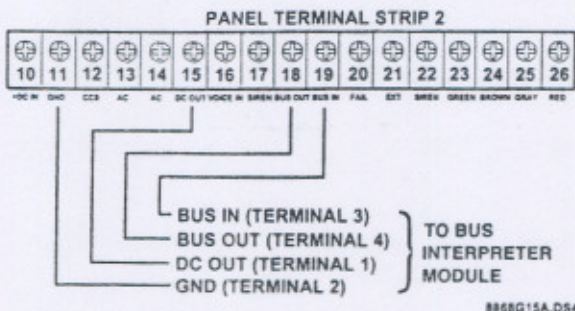

Figure 6. Wiring the Bus Interpreter Module to the Panel

Wiring the DIN 8-pin Cable to the Bus Interpreter Module

- 1) Connect the colored wires of the DIN 8-pin cable to the bus interpreter module as shown in Figure 7.

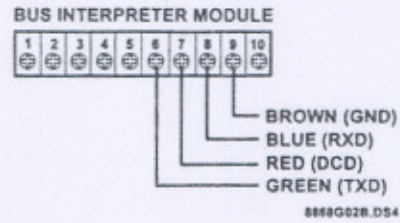

Figure 7. Wiring the DIN 8-pin Cable to the Bus Interpreter Module

- 2) Attach the enclosure cover on the bus interpreter module.

Installing the VuFone

- 1) Plug one end of the coiled handset wire into the modular jack on the handset and the other end into the modular jack labeled HANDSET on the VuFone left side (see Figure 8).

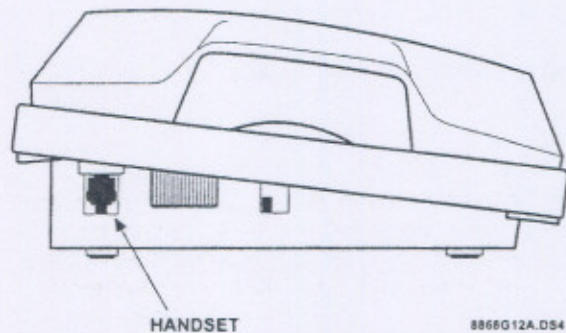

Figure 8. VuFone Handset Jack Location

- 2) Place the handset in the cradle.
- 3) Plug one end of the telephone line cord into the modular jack labeled TELCO on the VuFone rear panel (see Figure 9).

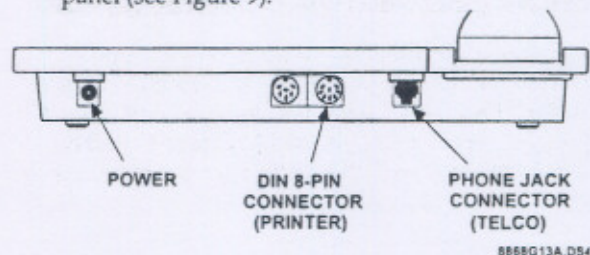

Figure 9. VuFone Rear Panel

- 4) Plug the other end of the cord into the telephone line wall jack. Use a modular wall plug adapter if necessary.
- 5) Remove the plastic plug from the VuFone PRINTER port and connect the DIN 8-pin cable (with the word *TOP* in the up position) into the port (see Figure 9).

Power Up

This section describes how to make power connections to the VuFone and how to apply power to the bus interpreter module and the panel.

WARNING: Always make connections to the ports on the rear panel before connecting the AC adapter.

- 1) Verify all wiring from the bus interpreter module to the panel and the VuFone (see Figures 6 and 7).
- 2) Plug the AC adapter cord into the power connector on the VuFone rear panel (see Figure 3).
- 3) Plug the AC adapter into an indoor 120-VAC outlet.
- 4) Turn on the panel power switch. This applies power to the panel and the bus interpreter module.

With the Tamper Bypass switch in the NORMAL position, the VuFone display should read PROGRAM MODE.

Note: If the message "PROGRAM MODE" is *not* displayed, check that the panel's Tamper Bypass switch is set to NORMAL and that all wiring connections are secured at the respective screw terminals. If the problem persists or the display reads "PLEASE WAIT" continuously, the VuFone unit ID number (default = 6) may need to be changed (see the following section, "Programming").

Programming

This section describes how to set up the VuFone system for communications with the panel. It also describes how to change the VuFone unit ID (if required), programming a latchkey sensor number, and options you have after establishing communications.

Note: For a review of the liquid crystal display (LCD) and related keys, see the *operator's manual* included with the VuFone.

Checking and Changing the Unit ID Number

To set up communications so that the panel recognizes the VuFone, perform the following:

- 1) Check the unit ID numbers of all devices connected to the hardwire bus, such as Hardwire Input Modules (HIMs), Hardwire Output Modules (HOMs), and touchpads. The VuFone default unit ID is 6.

If another bus device is set to ID number 6, the VuFone unit ID number must be changed. Go to step 3.

- 2) If no other devices on the bus are using unit ID number 6, press any of the buttons next to the menu options displayed. This causes the panel to search for new devices connected to the hardwire bus.

After pressing one of the buttons, the VuFone LCD displays the message "PLEASE WAIT" momentarily before displaying the menu for the respective programming item selected.

Note: If other devices have the same unit ID, then the VuFone continues displaying the message "PLEASE WAIT" until the conflicting device is removed from the bus.

- 3) Disconnect the device currently using unit ID 6.
- 4) Press the button next to the word "MISC." The LCD displays the message "PLEASE WAIT" momentarily before displaying the message "MISCELLANEOUS PROGRAMMING."
- 5) Press the button next to the words "UNIT #". The LCD displays the following:

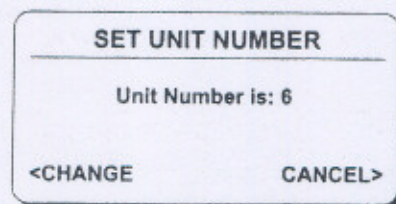

88041L00M

- 6) Press the button next to the word "CHANGE". The LCD displays the message "PLEASE WAIT" momentarily before displaying the following:

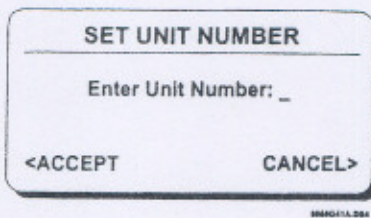

- 7) Enter the unit ID number that is currently not being used and then press the screen key adjacent to the word "ACCEPT". The LCD displays the message "PROGRAM FEATURE OK" momentarily before returning to the display shown in step 5.

Note: Repeat steps 3 through 7 or try another unit ID number if the VuFone does not display "PROGRAM FEATURE OK," or displays the following message:

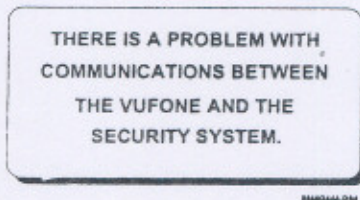

Programming a Latchkey Sensor Number

The latchkey feature allows the customer to set up a specific time the system must be disarmed to prevent a silent alarm and central station report.

This section describes how to program the latchkey sensor number so that a latchkey script can be set up. For information about how to set up a latchkey script, see the *VuFone Owner's Manual* (46-984).

- 1) With the panel in the program mode, press the *home* button to return to the main menu.
- 2) Press SENSORS (F6) and the screen briefly displays: PLEASE WAIT..
- 3) Press LATCHKEY (F6) and the screen briefly displays PLEASE WAIT..., then Learn Sn: NN (NN = the next available sensor number).
- 4) Press ACCEPT (F4) to use the displayed sensor number or enter a different (unused) sensor number (01-40) and press ACCEPT (F4). The screen briefly displays PLEASE WAIT..., then returns to the main menu.

This completes the latchkey sensor number programming.

What to Do Next

When communications between the VuFone and the panel are functioning properly, you can proceed by either returning to the main menu or programming the system:

- If programming from the VuFone is *not* necessary, replace the panel cover. The LCD display returns to the main menu screen:

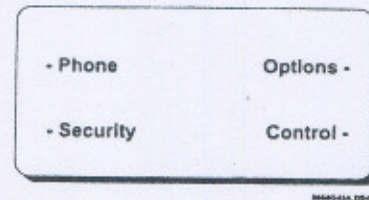

- If you wish to program the system, press the *home* button. The LCD displays the top level PROGRAM MODE menu screen:

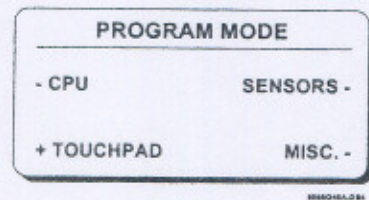

Note: For programming sequences from the top level PROGRAM MODE menu screen, see the section "Programming Sequences."

Note: If upper sensor numbers 84 (opening report) and 85 (closing report) are turned on, the VuFone Quickarm feature must be turned off.

Programming Sequences

This section describes how to perform a variety of programming tasks from the VuFone. Programming the panel from the VuFone can be divided into four main sequences:

- Configuring the panel (PANEL)
- Learning the RF touchpads (TOUCHPADS)
- Configuring sensors (SENSORS)
- Miscellaneous programming (MISC.)

When you use the VuFone to program the Security Pro 4000 system, you can begin programming after the communications setup procedure is successfully completed. To program from the VuFone, press the *home* button while in the current menu to display the top level PROGRAM MODE menu screen.

Note: For more information related to security system preparation and the programming process, see the *CareTaker Plus and Custom Versions Installation Manual* (46-504).

From the PROGRAM MODE menu screen, you can select any of four main programming tasks: PANEL, TOUCHPADS, SENSORS, and MISC.

To assist you in making the programming quick and easy, a series of flowcharts (numbered 1.0 through 4.4) is provided in the following pages.

Flowchart 1.0 represents the top level menu screen (PROGRAM MODE) from where programming begins.

Each flowchart thereafter represents submenu screens and related options that the LCD will display as you select each screen option and subsequently move through the menu screens.

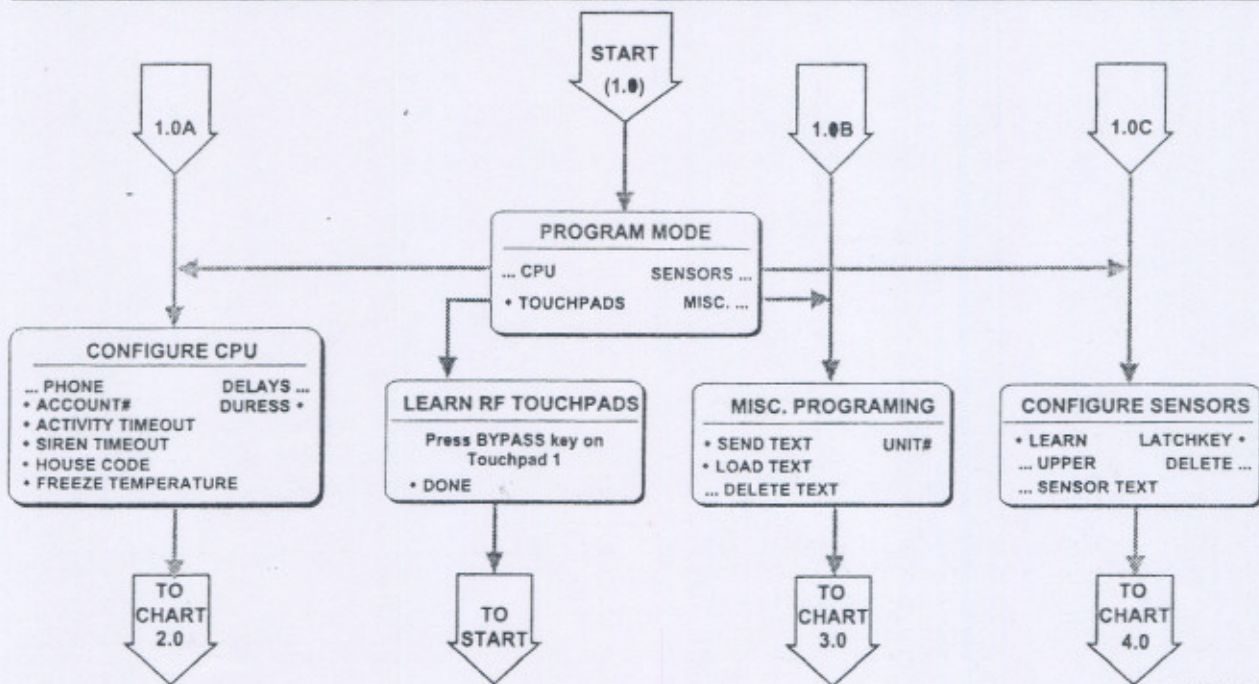

888G17A.DS4

Flowchart 1.0. Start programming at PROGRAM MODE screen; select any four main menu options: PANELS, TOUCHPADS, SENSORS, MISC. (MISCELLANEOUS)

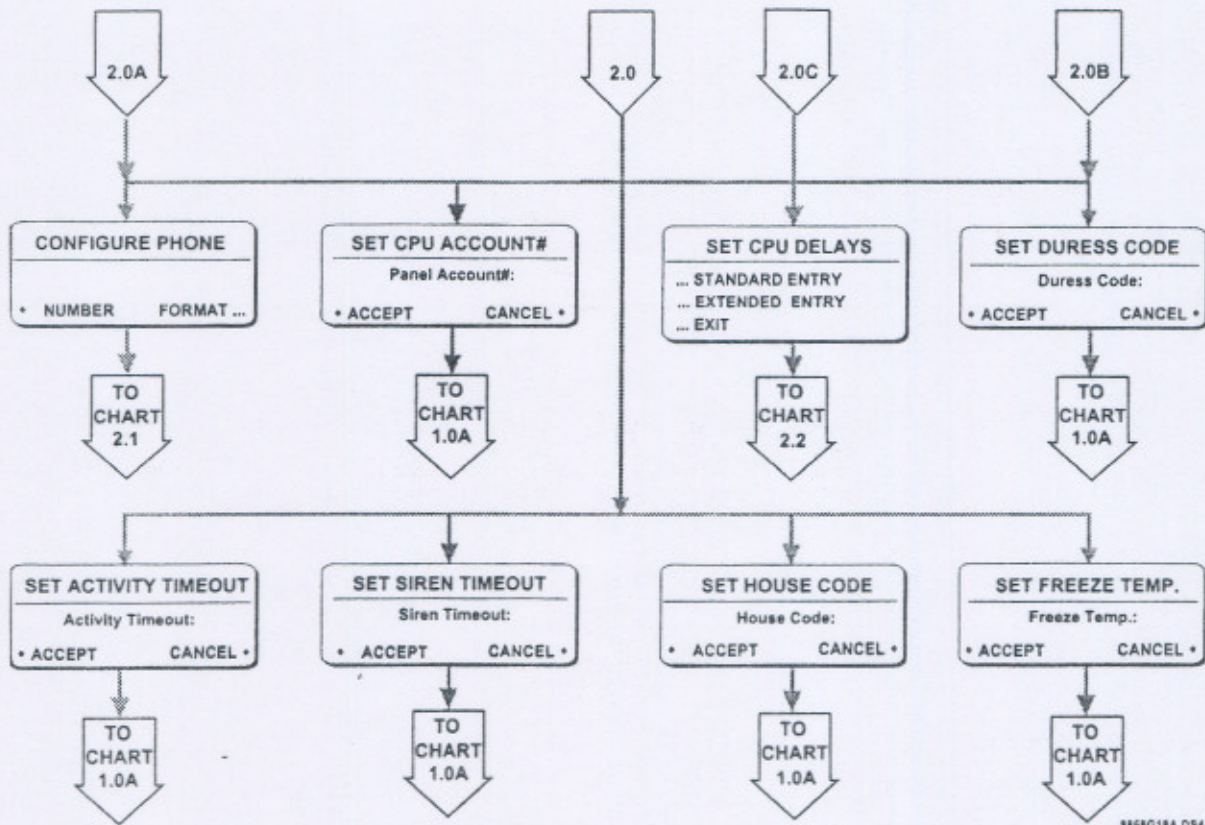

Flowchart 2.0. CONFIGURE PANEL Options

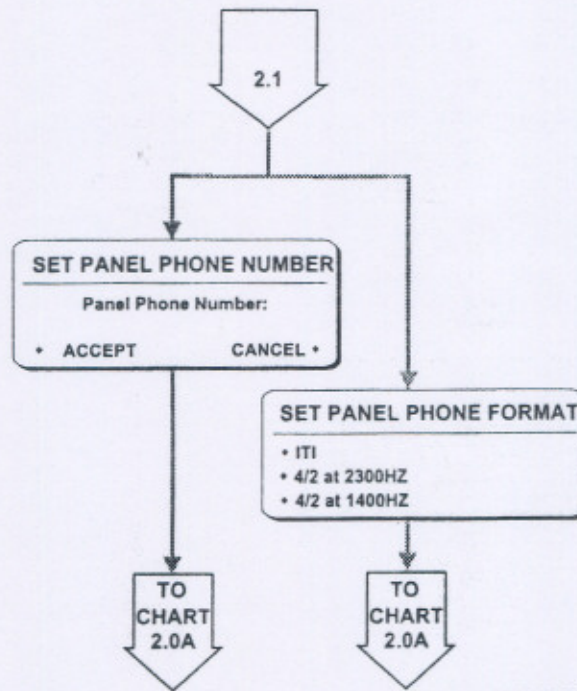

Flowchart 2.1. CONFIGURE PHONE Options

Programming Options

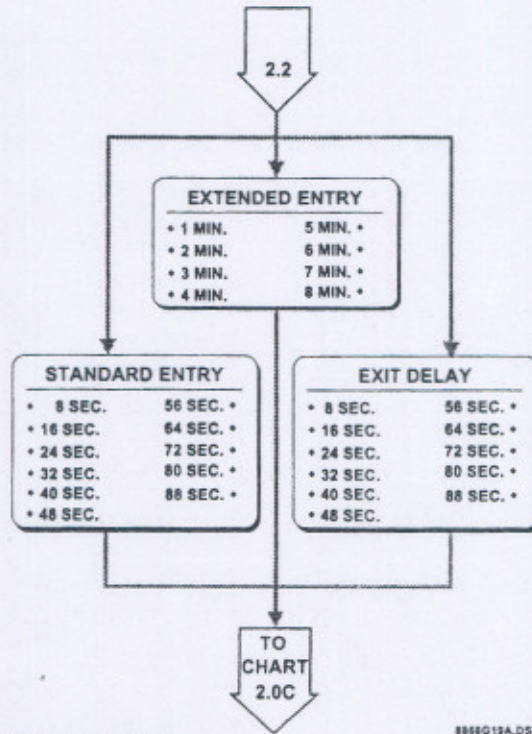

888G19A.D54

Flowchart 2.2. SET PANEL DELAYS Options

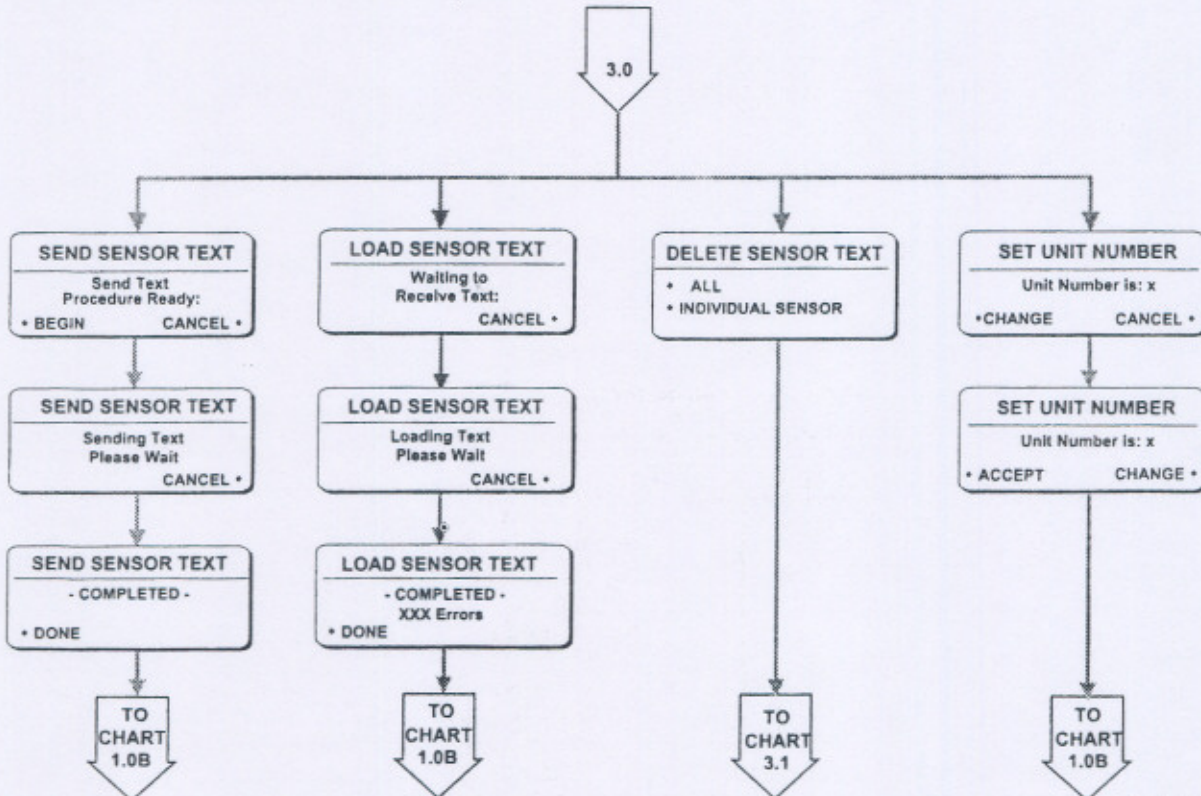

888G20A.D54

Flowchart 3.0. MISC. (MISCELLANEOUS)

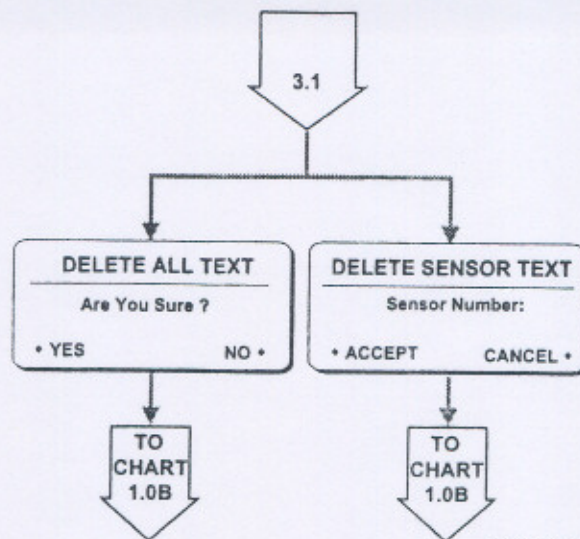

8868022A.D54

Flowchart 3.1. DELETE SENSOR TEXT Options

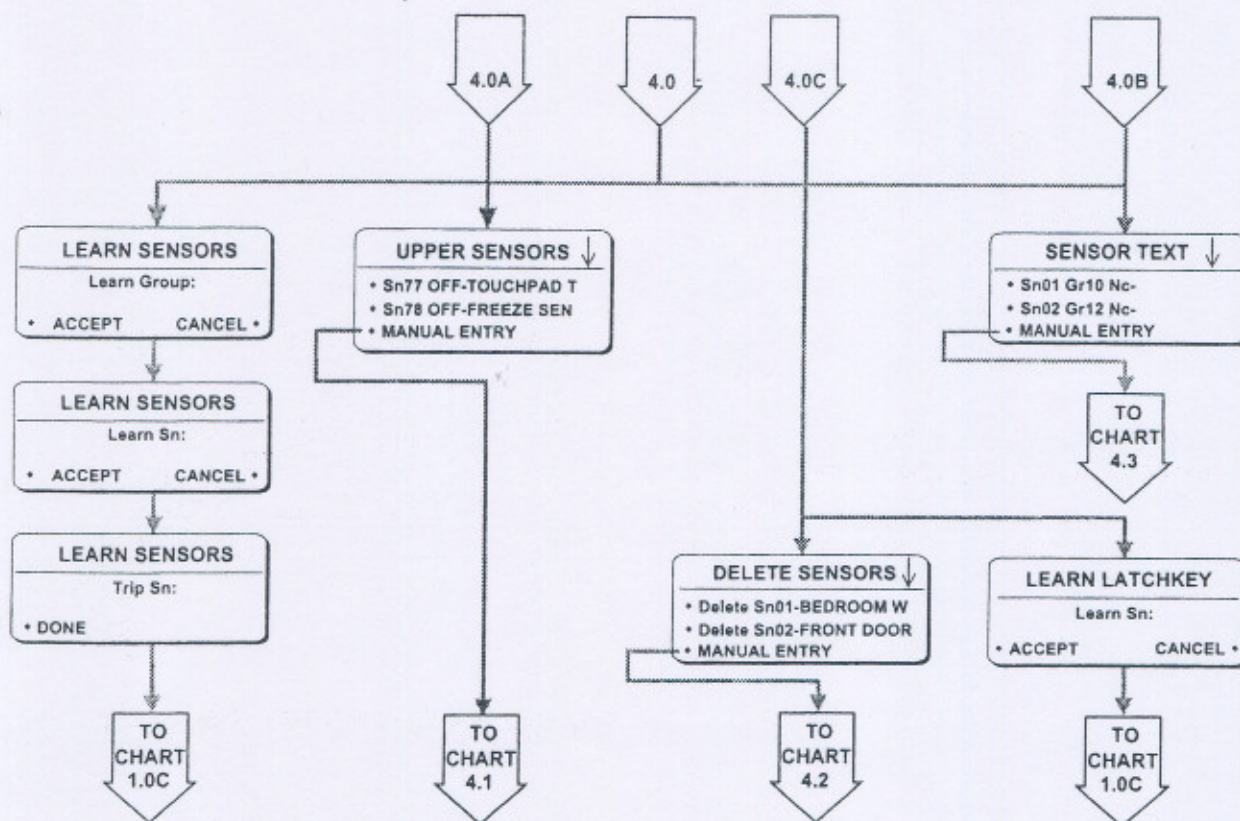

8868023A.D54

Flowchart 4.0. CONFIGURE SENSORS

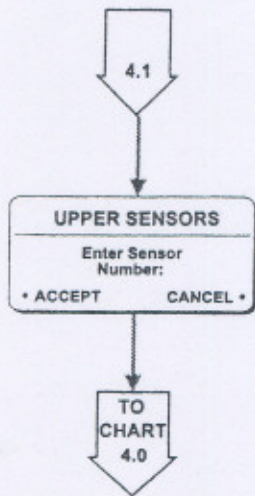

886G027A.D54

Flowchart 4.1. UPPER SENSORS Options

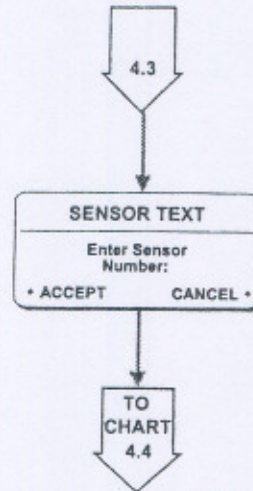

886G025A.D54

Flowchart 4.3. SENSOR TEXT Options

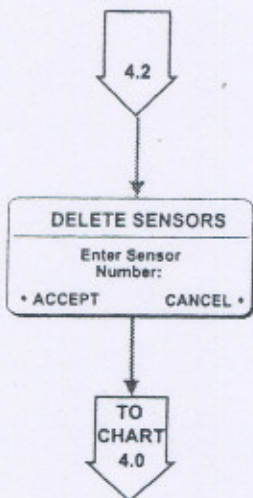

886G026A.D54

Flowchart 4.2. DELETE SENSORS Options

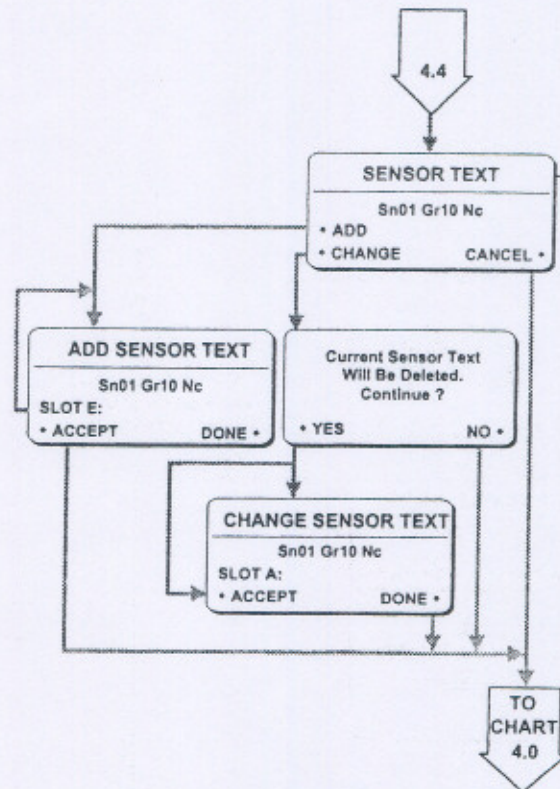

Flowchart 4.4. SENSOR TEXT Options (cont.)